



CLASSIC



11005



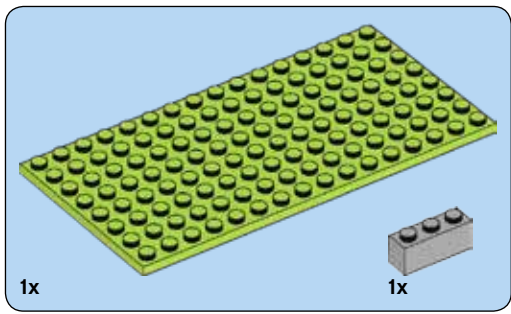

1

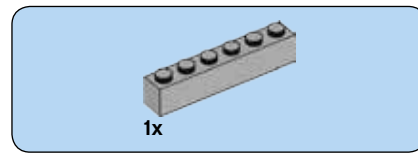
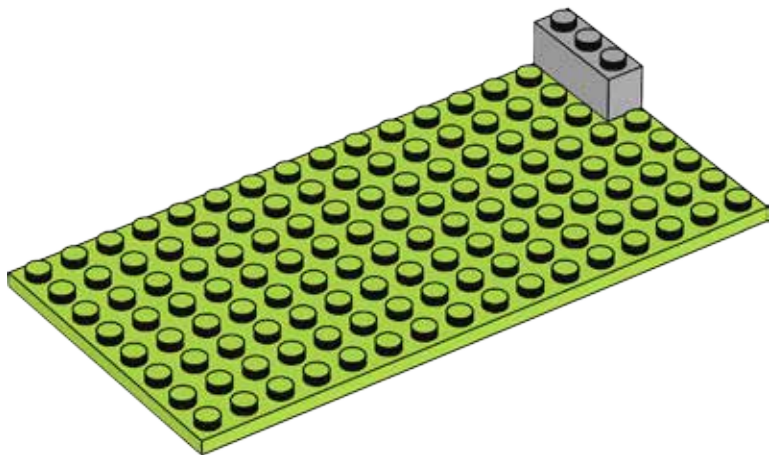

2

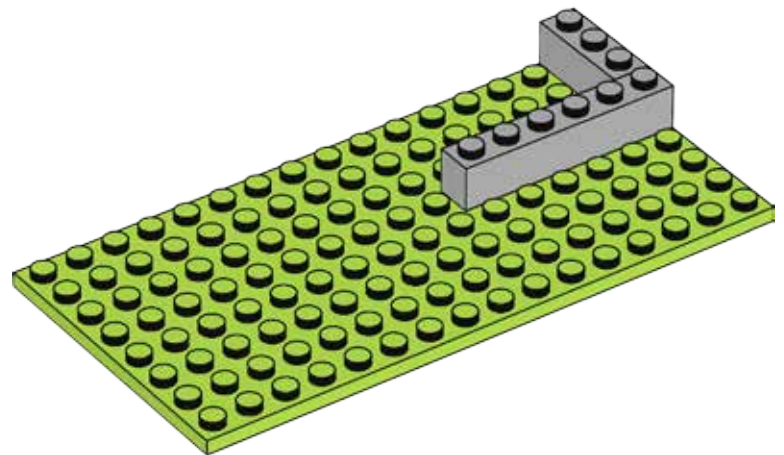

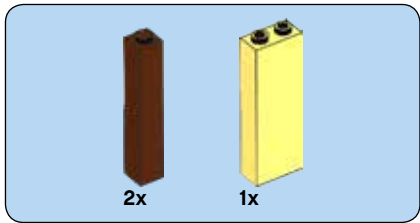

3

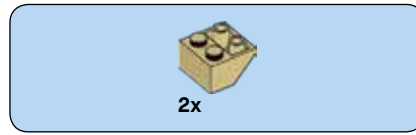
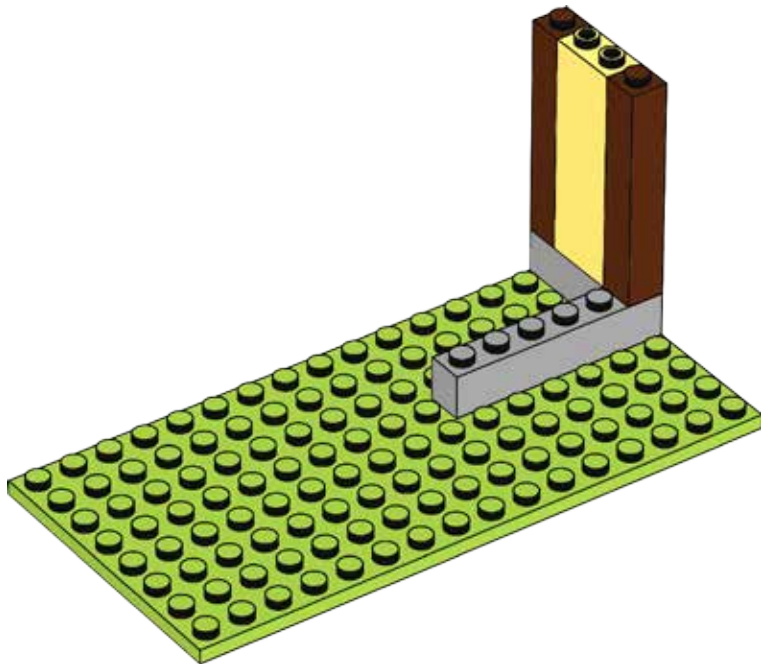

4

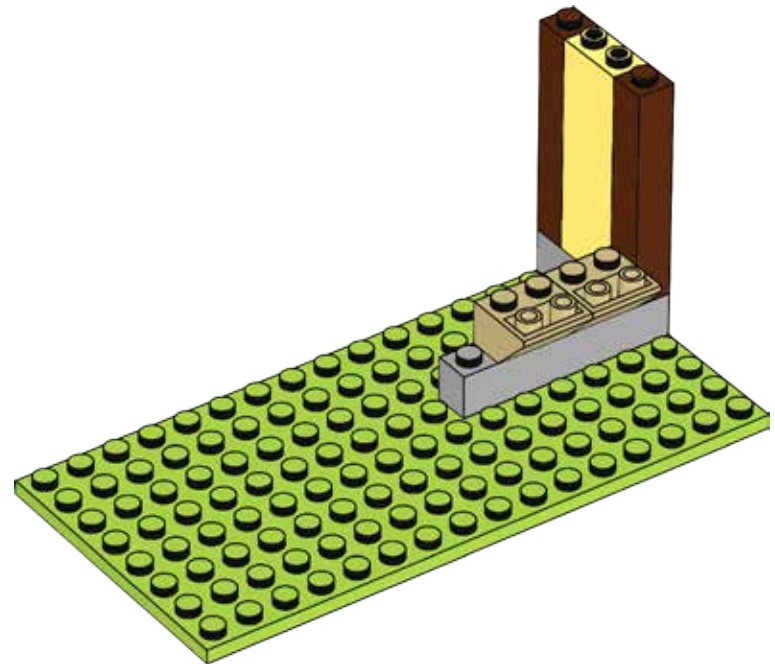

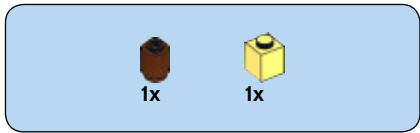

5

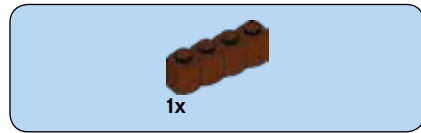
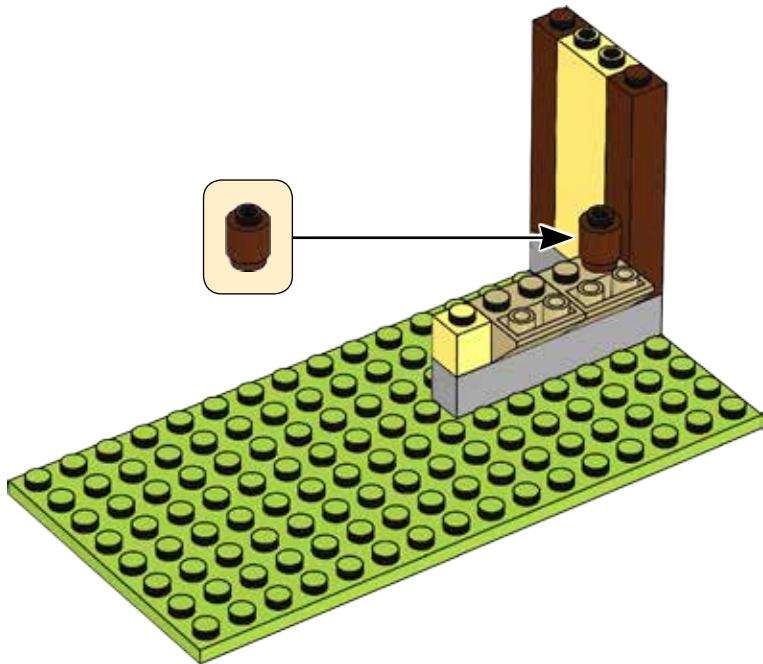

6

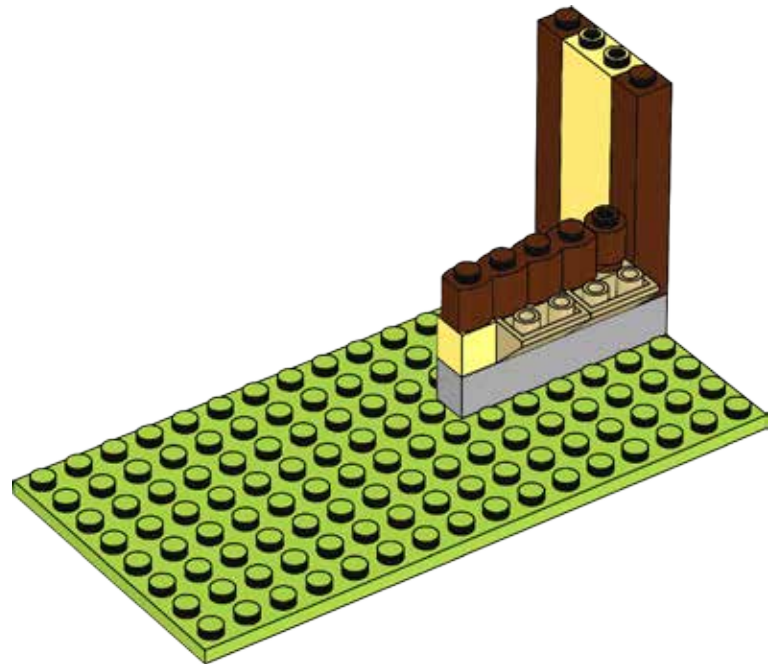

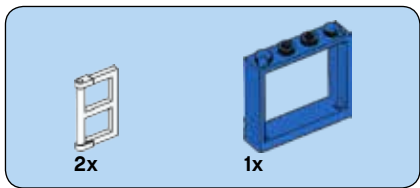

7

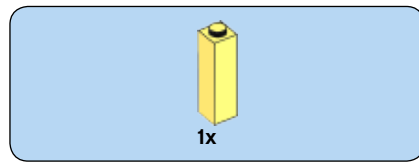
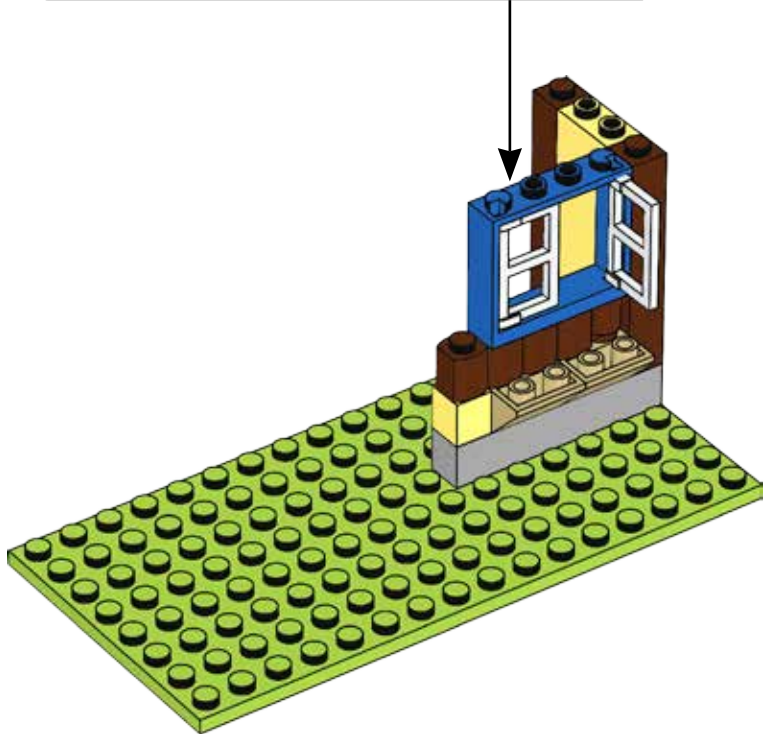
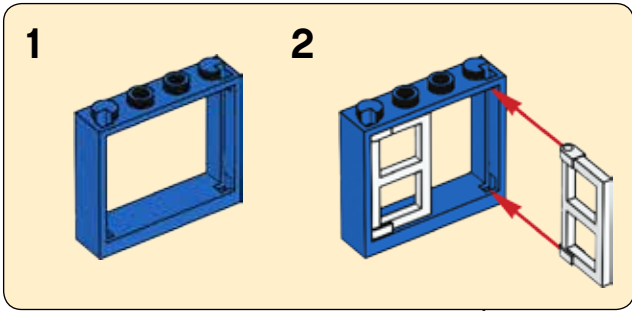

8

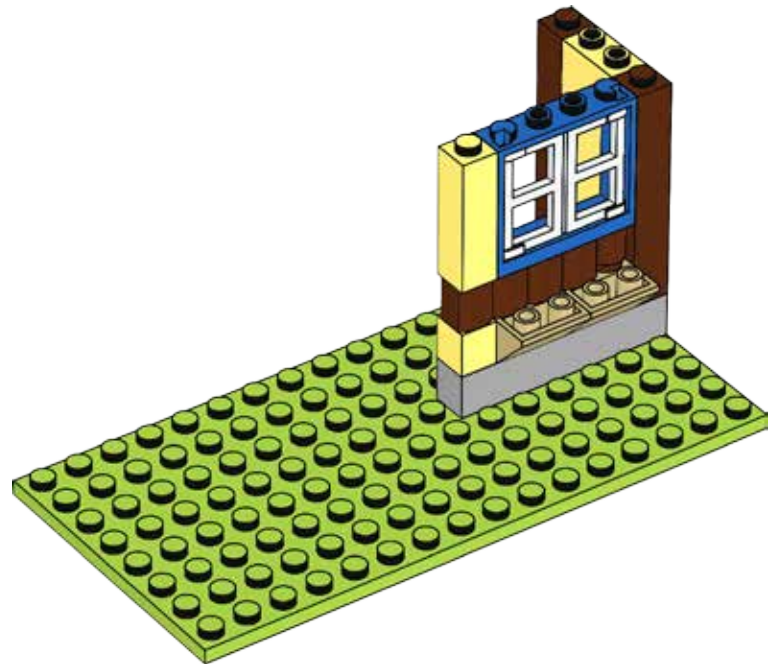

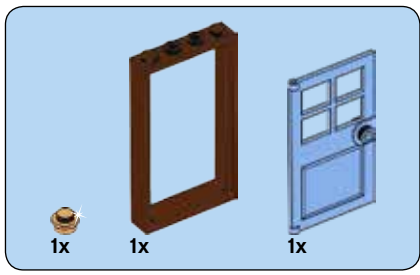

9

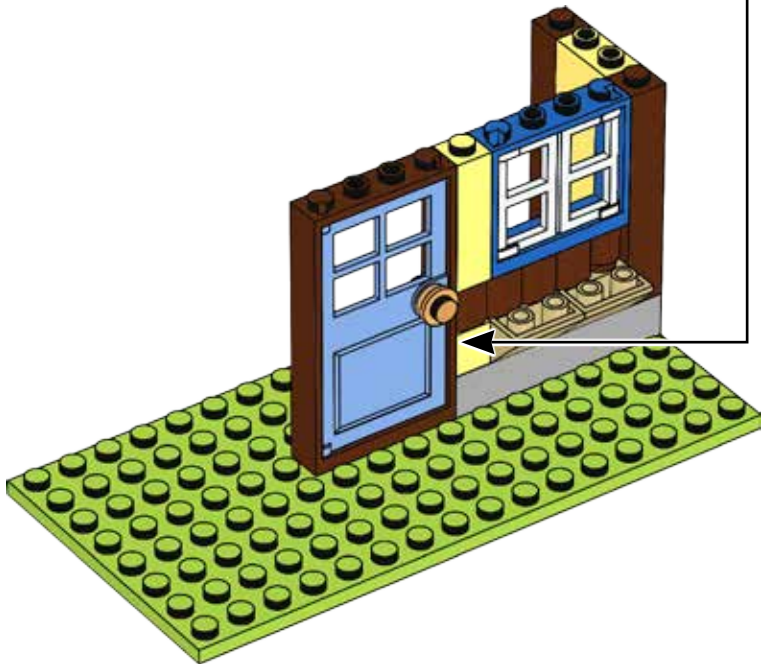
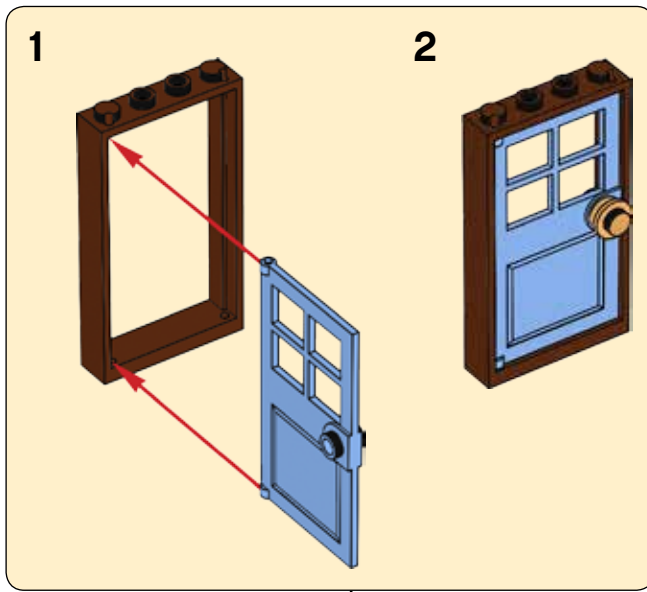

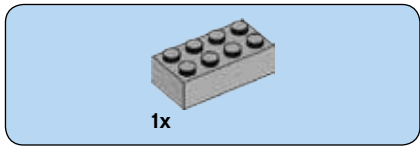

10

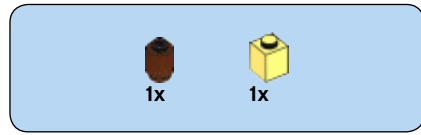

11





1x

12



2x



1x

13





14

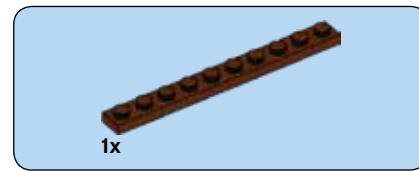
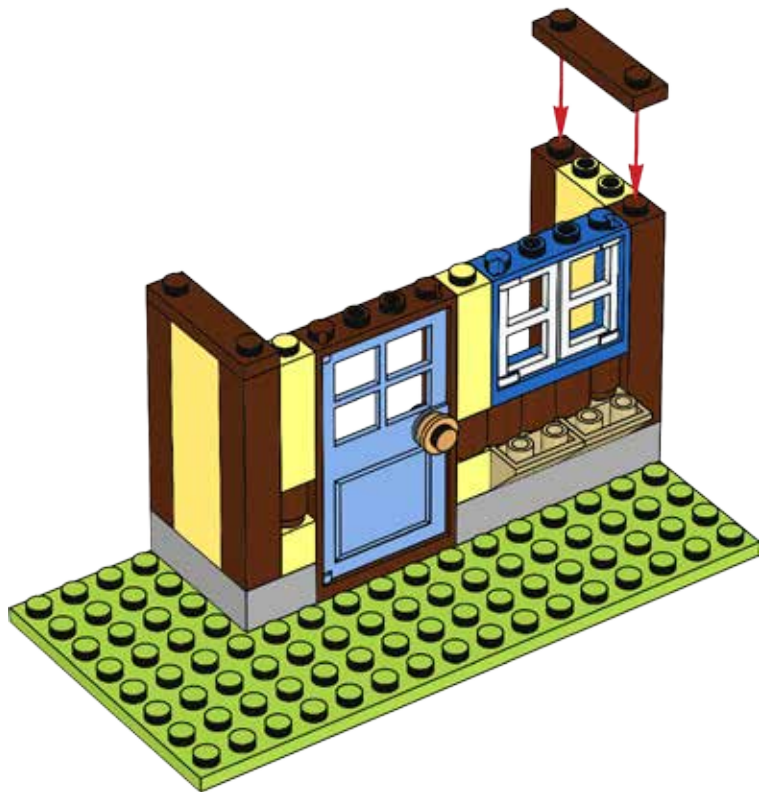

15

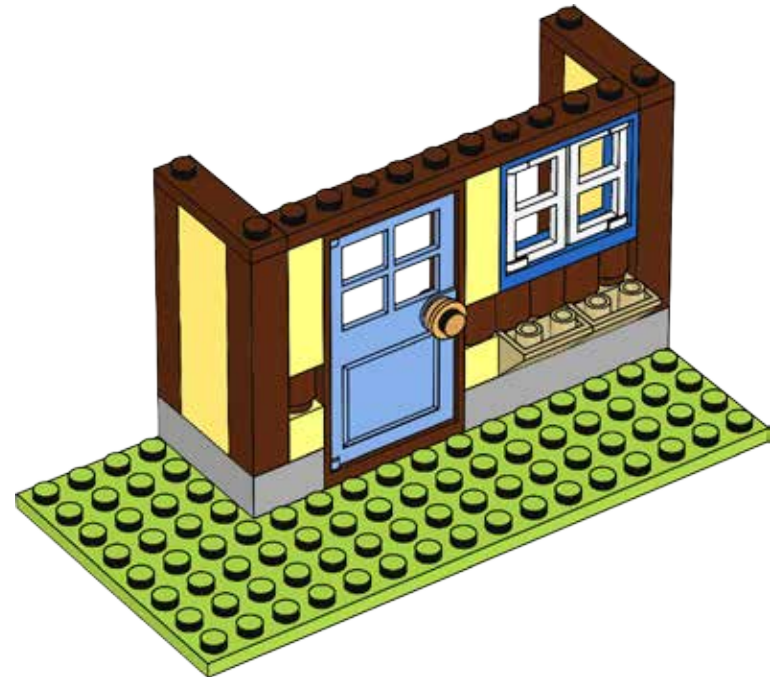



16

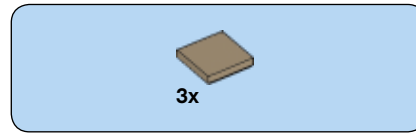
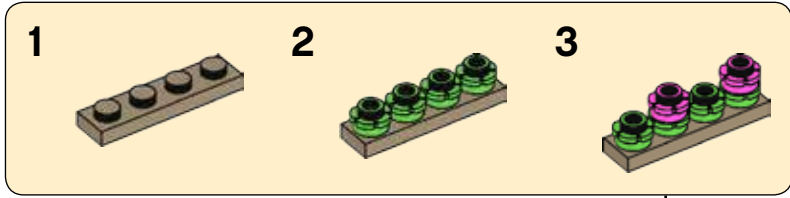

17





4x

18



2x



3x

19



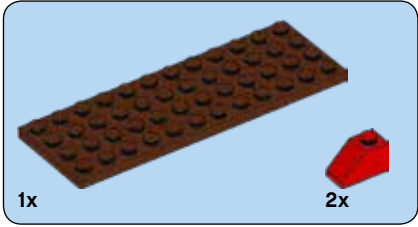
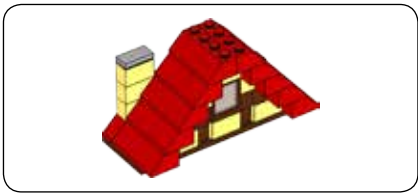

20

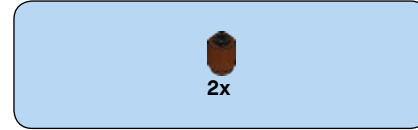
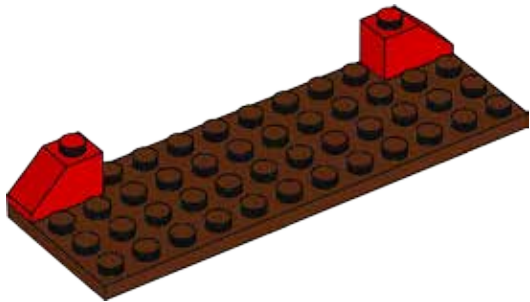

21

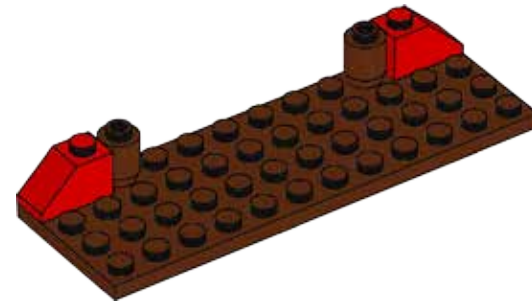

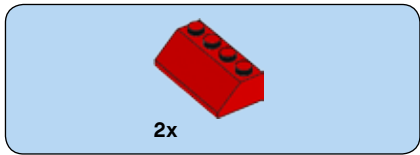

22

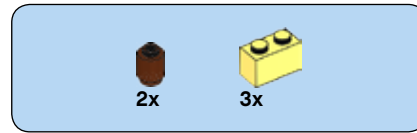
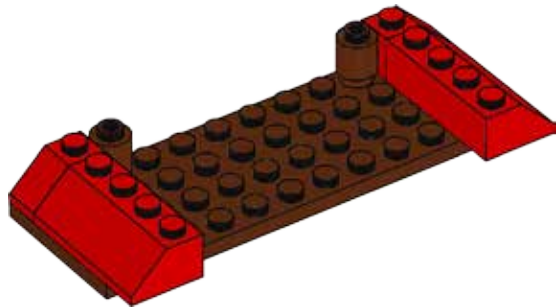

23

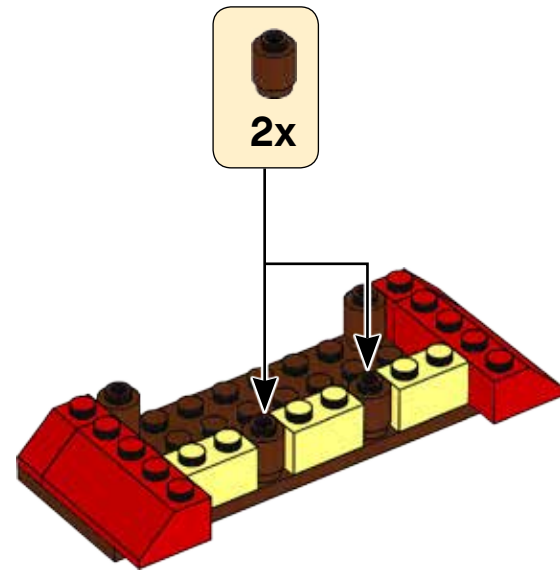

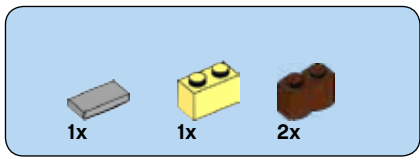

24

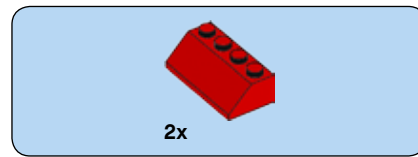
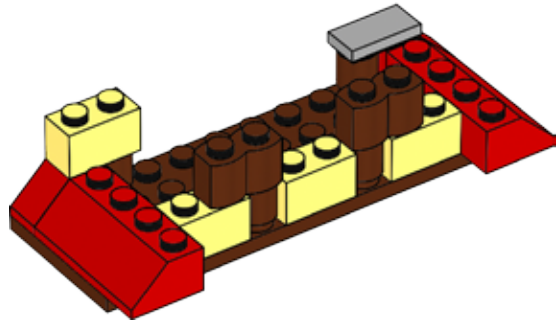

25

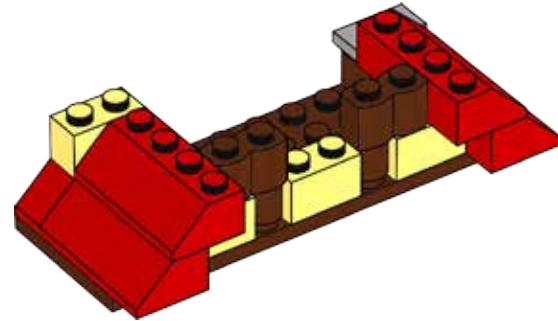

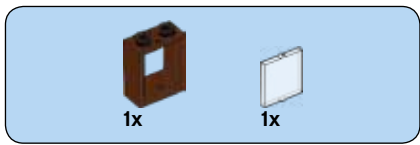

26

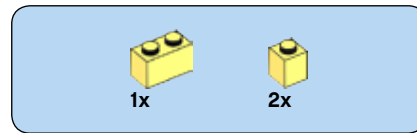
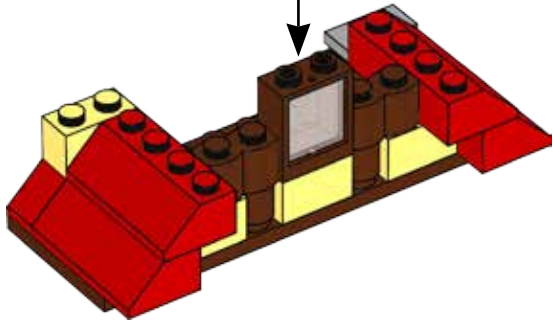
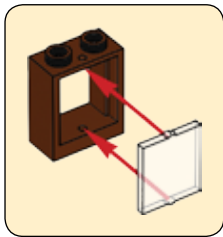

27

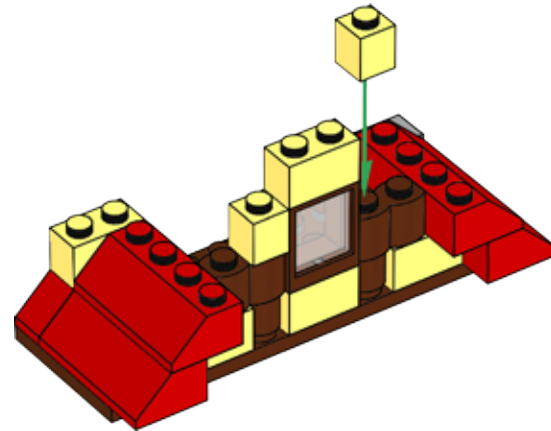

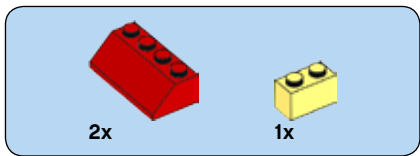

28

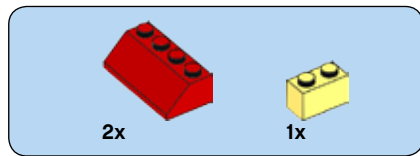
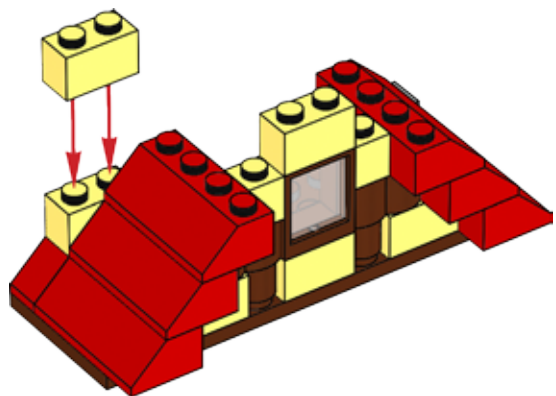

29

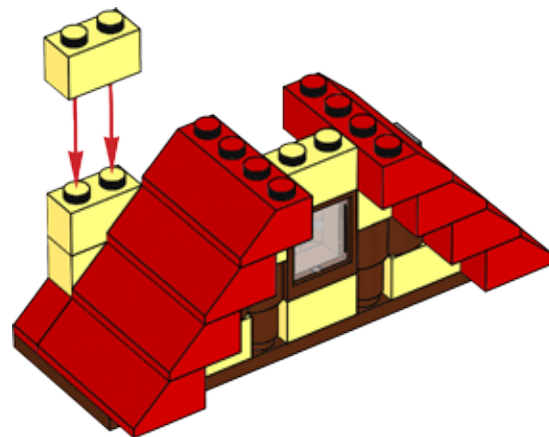

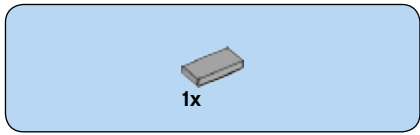

30

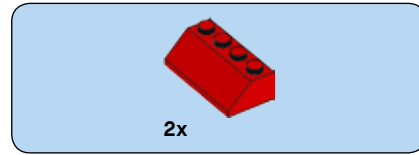
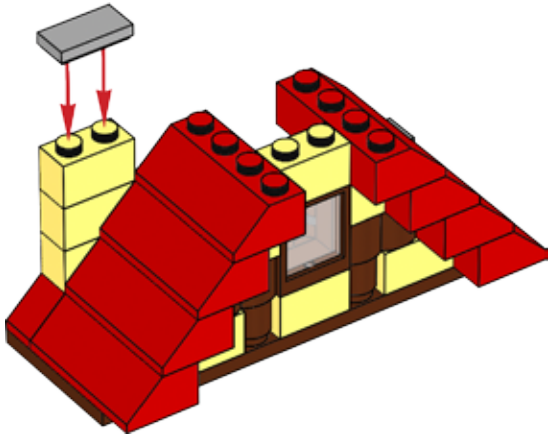

31

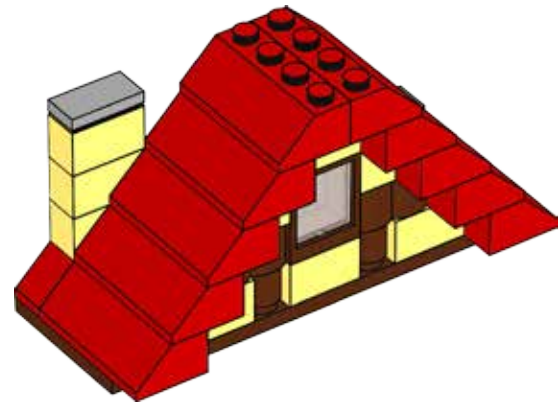

32

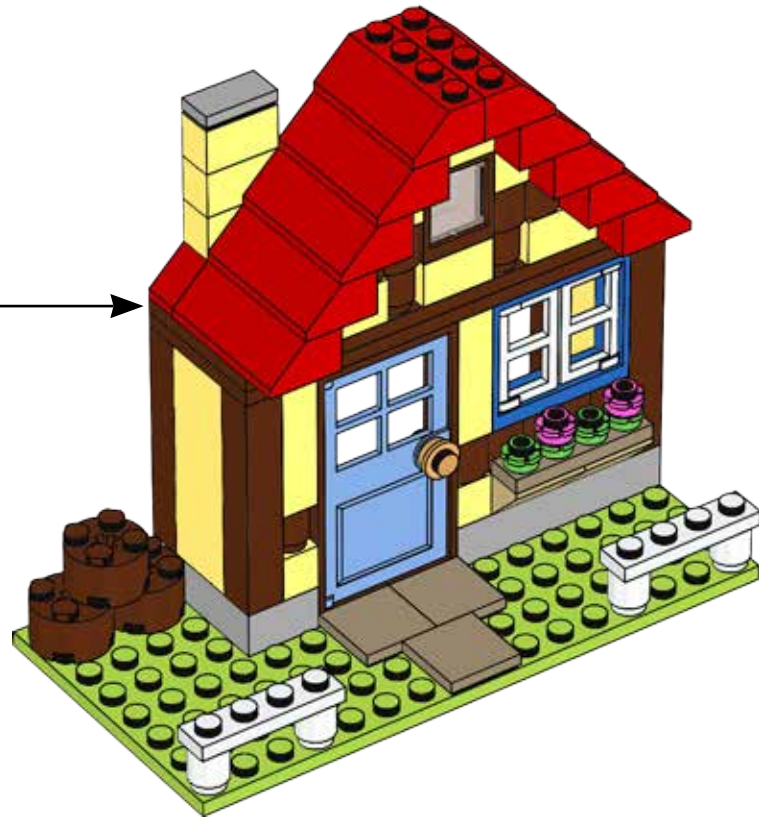



LEGO and the LEGO logo are trademarks of the/sont des marques de commerce du/son marcas registradas de LEGO Group. ©2019 The LEGO Group.